

# LUMEN-CAM™

“ILLUMINATING THE EVIDENCE”

## User Manual

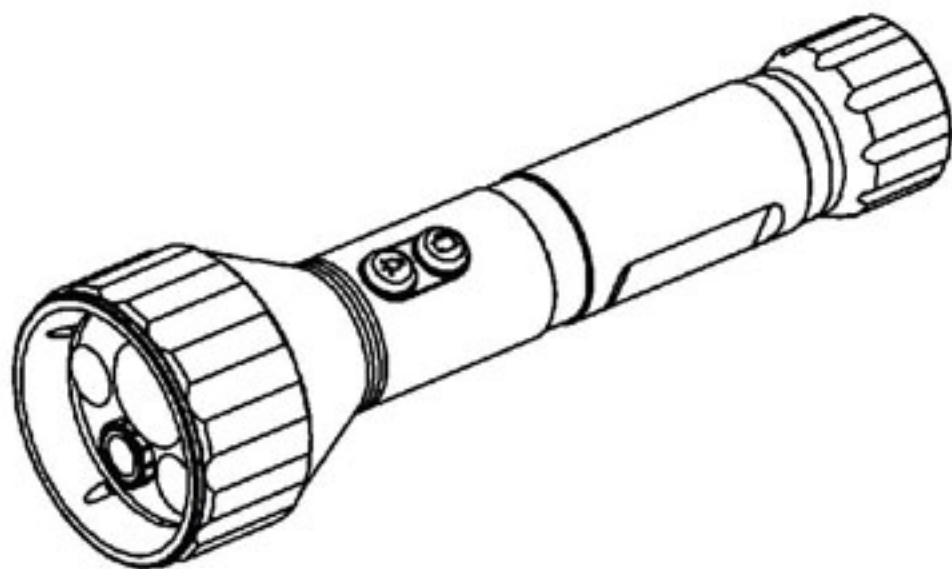

# HIGH-LUMEN LED LIGHT WITH BUILT-IN DIGITAL VIDEO RECORDER (DVR)

CE FC RoHS

[www.LumenCam.com](http://www.LumenCam.com)

## WELCOME

Congratulations on your purchase of the LumenCam™! This high quality flashlight with Digital Video Recorder (DVR) will add years of safety to what you do, as well as document evidence, inventory, events, people, or activities.

Please read the user manual carefully before using this product.

### PACKING LIST

- ① LumenCam™ x 1
- ② USB Cable x 1
- ③ Software CD x 1
- ④ Power Adapter x 1
- ⑤ Safety Strap x 1
- ⑥ Lithium Battery x 1

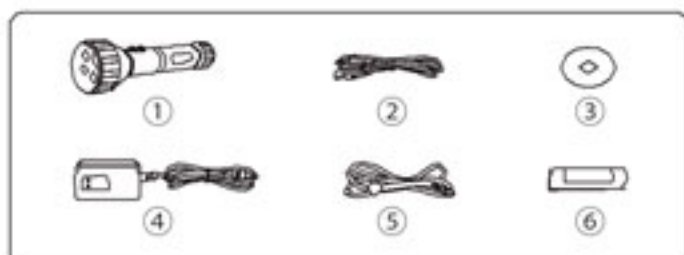

The pictures are for reference only, please refer to actual product.

## STRUCTURE

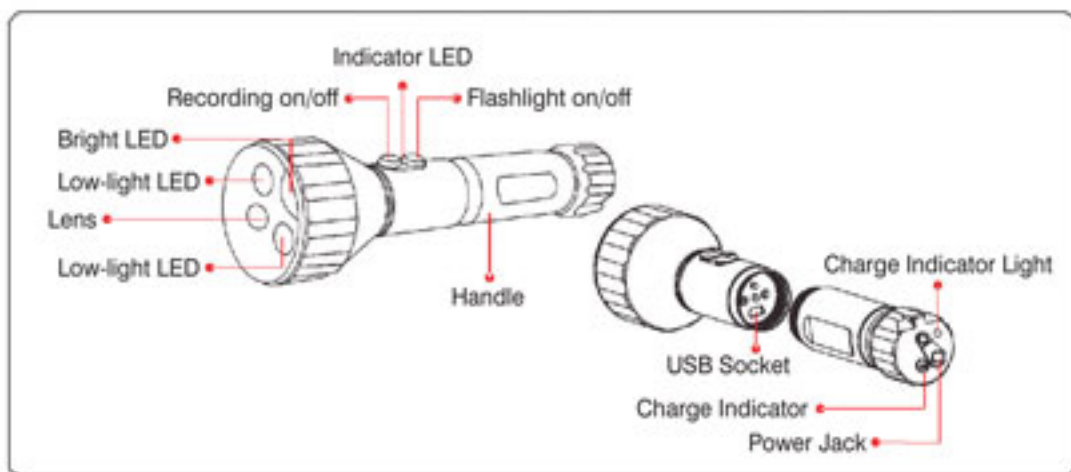

## OPERATION GUIDE

### Basic Operation:

1. Press the flashlight on/off button once for ultra-bright setting, suitable for illuminating distant objects. Press again for wide angle setting, suitable for lighting nearby objects. Press a third time to turn off flashlight;
2. Press the recording on/off button to start recording and once again to stop. A flashing blue working indicator LED light indicates recording in progress.

**TIP!** When recording objects up close at night, it is recommended to use the wide angle LED setting.

### Video Output:

1. Unscrew the handle of LumenCam™ and locate the USB port.
2. Using the included USB cable, connect LumenCam™ to any computer with a USB port.
3. Your computer should automatically recognize the new hardware, which you may browse by double-clicking on the My Computer icon on your desktop, and then navigating into the Mobile Disk directory.

\* If your computer is unable to playback desired video files, please first install the video player software from the included CD.

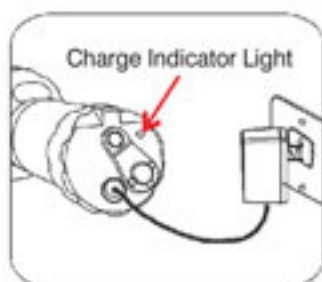
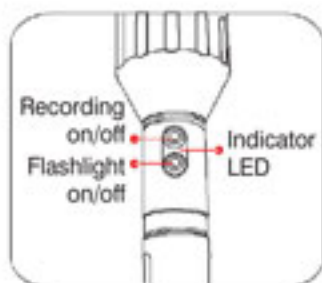

### Installing Lithium Battery:

1. Unscrew the handle of LumenCam™ and locate the handle;
2. Insert the Li-battery into the handle with proper orientation.

### Recharging Lithium Battery:

1. Locate and remove the waterproofing plug at the base of LumenCam™;
2. Connect the power adapter to LumenCam™ and an (100-240V ~ 50/60Hz) power source. The indicator will illuminate green when charging, and turn off when fully charged.

## NOTES:

1. The indicator LED flashing red signifies critically low battery, recharge immediately. If power is completely exhausted, the file you are recording will be saved automatically before shutting down.
2. If your memory is full, pressing the recording on/off button will cause the blue Indicator LED to stop and recording will not take place,
3. When LumenCam™ is connected to your computer via USB cable, it acts as a separate drive where files may be stored.

### Date/Time Reset:

If the date/time of your video does not match the local date/time, please follow the these steps:

1. Set the date/time on your computer to match the local date/time;
2. Connect LumenCam™ to your computer via the USB cable provided;
3. Double-click the My Computer icon on your desktop, and then navigate into the Mobile Disk directory. This is the directory that the LumenCam™ SD card uses;
4. Insert the CD provided into your computer's CD drive;
5. Search your CD drive for a file named 'getsystemTime.exe', copy and paste this file into the Mobile Disk folder;
6. Double click the file and wait for your system to automatically produce a



7. You may now close all folders and disconnect the USB cable, set up has been successfully completed.

### Formatting Memory:

It is highly recommended to use the software on the CD provided to format LumenCam™ built-in memory. Using the functions of a Windows PC system to format LumenCam™ will alter certain values, causing video file storage time to become slower. Follow the instructions below to format:

1. Insert the CD provided into your computer's CD drive, and search your CD drive for a file named 'UDiskFormat.exe' and double-click on this file:

2. In the dialogue window, enter the disk name that LumenCam™ is given when it is connected to your computer, e.g., H:/, G:/, etc. (open 'My Computer' to locate the disk name):

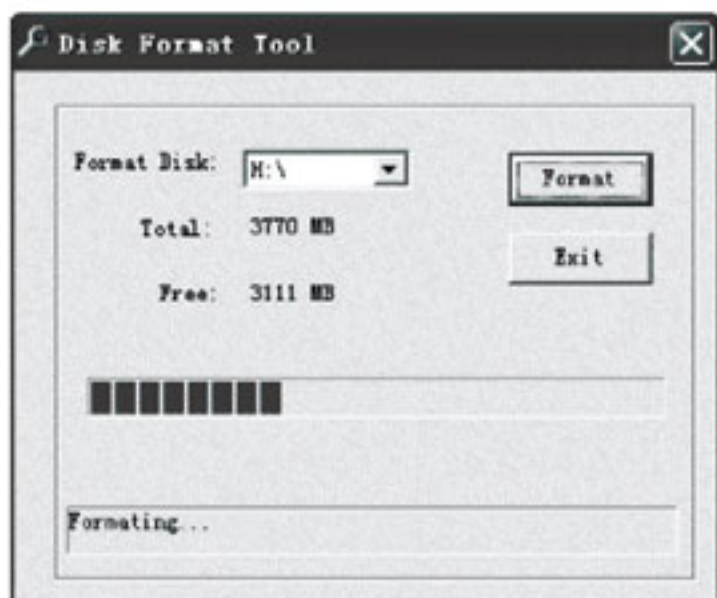

3. Click 'Format' to format the memory, or 'Exit' to close.

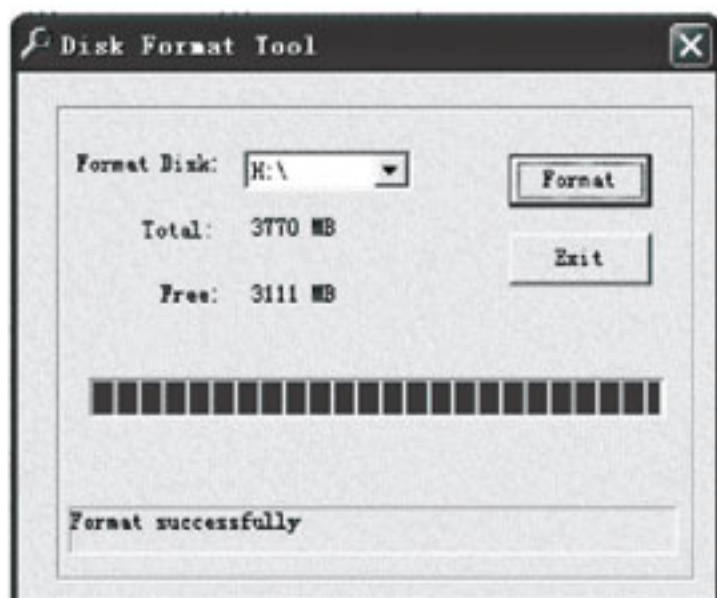

4. After formatting successfully, you may click 'Exit'.

[www.LumenCam.com](http://www.LumenCam.com)

## PROPER RECORDING ORIENTATION



Please ensure that the recording on/off and flashlight on/off buttons are facing upwards during recording, otherwise video files will not display correctly.

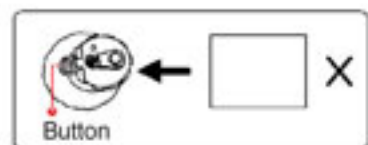

## NOTICE

- Turn off the LumenCam™ if not in use;
- Do not put the battery in fire or water. Dispose of properly;
- Do not use metal objects to connect the battery polarities;
- Do not open the battery;

[www.LumenCam.com](http://www.LumenCam.com)

## SPECIFICATIONS

Model No.	LumenCam
Imaging Sensor	1/4-inch Color CMOS
Video Resolution	640 x 480
Viewing Angle	56°
Video Format	.AVI
Video File Size	>15M Byte/ minute
Viewing Resolution	640 x 480 (VGA)
Storage Medium	Built-in Memory with up to 4GB
Power Supply	Li-battery (3.7V/2000mAH)
Charging Time	4 hours (Max.)
Data transmission	USB 2.0
Working Time	3.5 hours of continuous light and DVR operation
LED Light Power	1W / 180 Lumen
LED Light Color Temperature	>5500K
<b>Waterproof Capacity</b>	<b>IP65</b>
Consumption Current (Max.)	560mA
Charging Current	>800mA
Dimensions (W x D x H)	191 x 56 x 56 (mm)
Approx. Weight	300g
Operating Temperature	0°C~50°C
Operating Humidity	15~85%RH

\* All the specifications are subject to minor change without prior notice.

## FCC Information

This device complies with part 15 of the FCC Rules. Operation is subject to the following two conditions:

- (1) this device may not cause harmful interference;
- (2) this device must accept any interference received, including interference that may cause undesired operation. Changes or modifications not expressly approved by the party responsible for compliance could void the user's authority to operate the equipment.

**LUMENCAM™**  
"ILLUMINATING THE EVIDENCE"

[www.LumenCam.com](http://www.LumenCam.com)

349 n. Vinewood St.  
Escondido, CA 92029  
800.959.2899

### EU Environmental Protection

Waste electrical products should not be disposed of with household waste. Please recycle where facilities exist. Check with your local authority or retailer for recycling advice.



PAP